

# EasySampler 1210

## Sampling Made Easy





# Table of Contents

|          |   |           |
|----------|---|-----------|
| <b>1</b> | <b>Introduction</b>   | <b>3</b>  |
| 1.1      | Scope of delivery .....   | 3         |
| 1.2      | Check on arrival .....  | 4         |
| <b>2</b> | <b>Safety Information</b>   | <b>5</b>  |
| 2.1      | Definition of signal warnings and symbols.....                        | 5         |
| 2.2      | Intended use .....  | 5         |
| 2.3      | Product specific warnings and symbols.....                            | 5         |
| <b>3</b> | <b>Overview</b>   | <b>7</b>  |
| <b>4</b> | <b>Installation</b>   | <b>8</b>  |
| 4.1      | Installation requirements.....  | 8         |
| 4.2      | Transport the device.....   | 8         |
| 4.3      | Install the vial rack.....  | 8         |
| 4.4      | Connect the sampling probe.....                                       | 9         |
| 4.5      | Install the needle.....   | 9         |
| 4.6      | Connect power to device.....  | 10        |
| 4.7      | Turn on device.....   | 11        |
| <b>5</b> | <b>Operation</b>  | <b>12</b> |
| 5.1      | Rinse the pump .....  | 12        |
| 5.2      | Clean .....   | 12        |
| 5.3      | Prepare .....   | 14        |
| 5.4      | Take 1 Sample .....   | 15        |
| <b>6</b> | <b>Maintenance</b>  | <b>16</b> |
| 6.1      | Pause during the Operation of EasySampler 1210.....                   | 16        |
| 6.2      | Checking for Leaks.....   | 16        |
| 6.3      | Cleaning the EasySampler 1210 .....                                   | 16        |
| 6.4      | Touchscreen Firmware Update.....                                      | 17        |
| 6.5      | Disposal .....  | 17        |
| <b>7</b> | <b>Technical Data</b>   | <b>18</b> |
| 7.1      | Solvent compatibility .....   | 19        |
| 7.2      | Dimensions.....   | 19        |
| 7.2.1    | Device Dimensions .....   | 19        |
| 7.2.2    | Probe Dimensions.....   | 19        |
| <b>8</b> | <b>Certifications</b>   | <b>21</b> |
| 8.1      | Information_Notice_EasySampler_Pressure Directive_2014_68_EU.pdf..... | 21        |



# 1 Introduction







EasySampler 1210 enables automated and unattended sampling of chemical reactions 24/7. The unique sampling probe facilitates sampling of a wide range of chemical reactions with precision, including heterogeneous reactions, reactions at elevated pressure and sub-ambient temperatures, as well as air and moisture sensitive chemistries. The representative samples gained with EasySampler 1210 provide accurate analytical data for improved reaction understanding while increasing chemists' productivity.

Using the EasySampler Connectivity kit you have the EasySampler 1210 functions available on the EasyMax, OptiMax, RX-10 and RC1mx. Additionally sampling information is added to the experiment and is exported with the experiment file.

Please also read the Operating Instructions for the full scope of functionalities of the device. The Operating Instructions can be found on the USB stick.

## 1.1 Scope of delivery

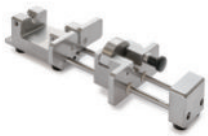
The following items are included in the EasySampler set (30083901):

|   | Description                                     | Order No. |
|---|---|-----------|
|    | EasySampler 1210 System                         |           |
|   | EasySampler 10 mL rack                          | 30040993  |
|  | Vial (100 pieces), not assembled                | 30244745  |
|   | Vial (1000 pieces), not assembled               | 30111624  |
|  | Needle  | 30041011  |
|  | Sleeve Mounting And Removal Tool incl. Torx key | 30213880  |
|  | Waste bottle 500 mL GL55                        | 30072069  |
|   | Screw cap for 500 mL waste bottle, GL55         | 30094594  |
|   | Septum for GL55                                 | 30306192  |

|   |                                  |          |
|---|----------------------------------|----------|
|  | Bottle 250 mL with cap, GL45     | 51191591 |
|   | Distributor cap, GL45, 2 x GL14  | 51191972 |
|   | Screw Cap GL14, without aperture | 51190318 |
|   | Screw cap GL14, with aperture    | 51190317 |
|   | Silicone rubber seal             | 51191170 |

|   |                              |          |
|---|------------------------------|----------|
|  | EasySampler Pump Rinsing Set | 30466882 |
|   | • 1x PTFE tubing             |          |
|   | • 1x Luer locker adapter     |          |
|   | • 1x Syringe (10 mL)         |          |

User Manual  
 USB stick RXE/CSS with documents

There are additional parts that are needed for proper function of the system:

|                              |          |
|------------------------------|----------|
| EasySampler Connectivity kit | 30110344 |
|------------------------------|----------|

**EasySampler probes**

|   |                           |          |
|---|---------------------------|----------|
|  | EasySampler Probe 210 set | 30246344 |
|   | EasySampler Probe 330 Set | 30306933 |
|   | EasySampler Probe 450 set | 30306037 |

**1.2 Check on arrival**

Check the following conditions once the package has arrived:

- The package is in good condition.
- The contents show no signs of damage (e.g. broken covers, scratches, etc.)
- The contents are complete (see [Scope of delivery Page 3]).

If any one of these condition is not fulfilled, please contact your local support team.

## 2 Safety Information

This device has been tested for the intended purposes described in this document. However, this does not absolve you from the responsibility of performing your own tests of the product supplied by us regarding its suitability for the methods and purposes you intend to use it for. You should therefore observe the following safety measures.

We, Mettler-Toledo GmbH, accept no liability whatsoever if you do not observe the following rules and safety notes for safe operation of the device.

### 2.1 Definition of signal warnings and symbols

Safety notes are marked with signal words and warning symbols. These show safety issues and warnings. Ignoring the safety notes may lead to personal injury, damage to the instrument, malfunctions and false results.

#### Signal words

|                |   |
|----------------|---|
| <b>WARNING</b> | A hazardous situation with medium risk, possibly resulting in death or severe injury if not avoided.  |
| <b>CAUTION</b> | A hazardous situation with low risk, resulting in minor or moderate injury if not avoided.  |
| <b>NOTICE</b>  | A hazardous situation with low risk, resulting in damage to the instrument, other material damage, malfunctions and erroneous results, or loss of data. |
| <b>Note</b>    | (no symbol)<br>for useful information about the product.  |

### 2.2 Intended use

EasySampler 1210 is intended to be operated in a laboratory and used by trained staff. It allows you to sample reactions that do not exceed a viscosity of 3 mPas.

Always operate and use your device in accordance with the instructions contained in this manual; use it only together with equipment specified in this documentation.

Any other type of use and operation beyond the limits of these technical specifications without the written consent from Mettler-Toledo GmbH is considered as not intended.

### 2.3 Product specific warnings and symbols



#### **WARNING**

##### **Risk of electric shock**

- 1 Make sure to plug the power cable supplied into a power supply outlet that is grounded. A technical fault could otherwise result in serious injury or death.
- 2 Only use the METTLER TOLEDO power supply cable and AC power adapter designed for your instrument.



#### **CAUTION**

##### **Potentially explosive environment**

The housing of EasySampler 1210 is not gas tight (explosion hazard due to spark formation, explosion caused by ingress of gases).

- 1 Never work in an environment subject to explosion hazards.
- 2 Avoid electrostatic charge formation.



#### **CAUTION**

##### **Crush Hazard**

An exposed needle can cause personal injuries.

- Do not remove the needle protection shield when EasySampler 1210 is ON.



## NOTICE

### **Risk of blocking fluid paths with solids in sample pocket**

The fluid lines may become blocked if solids in the sample pocket are not dissolved.

- Make sure to select appropriate Quench and Dilution solvents to dissolve the solids within 10 seconds.



## NOTICE

### **Risk of blocking pump with viscous solvents**

Pump blocks at 6 bar pressure.

- Make sure that the viscosity of the solvents used for Quench, Dilution and Reaction is not higher than 3 mPas.



## NOTICE

### **Sampling reaction at elevated pressure**

When using EasySampler 1210 to sample reactions at elevated pressure, do not exceed the operating conditions specified in the EasySampler 1210 technical data section.

For safe operation of the sampling probe, limit the maximum pressure in the reactor using an adequate rupture disc.

The Operating Instructions must be read and understood. Exceeding operating conditions can cause leak of reaction mixture and damage of EasySampler 1210 and/or the sampling probe.



### 3 Overview

#### EasySampler 1210 front

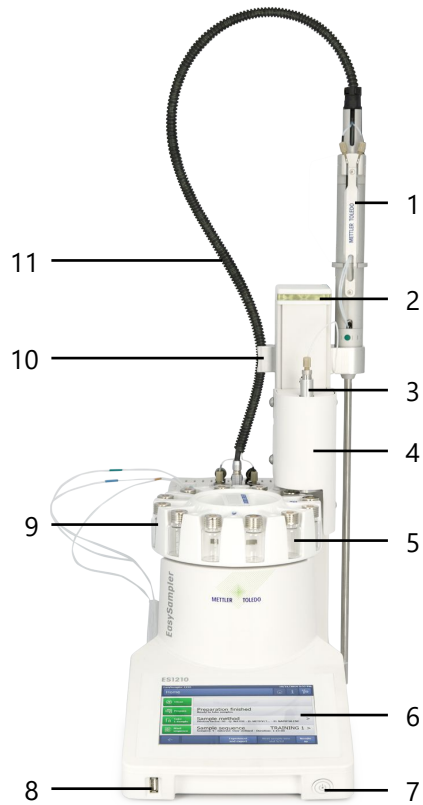

|   |                          |    |                             |
|---|--------------------------|----|-----------------------------|
| 1 | Sampling probe           | 7  | Power button                |
| 2 | Status LED               | 8  | USB port                    |
| 3 | Needle holder            | 9  | Rack (for 12 x 10 mL vials) |
| 4 | Needle protection shield | 10 | Conduit holder              |
| 5 | Vial (10 mL)             | 11 | Conduit                     |
| 6 | Touchscreen              |    |                             |

#### EasySampler 1210 back - connections

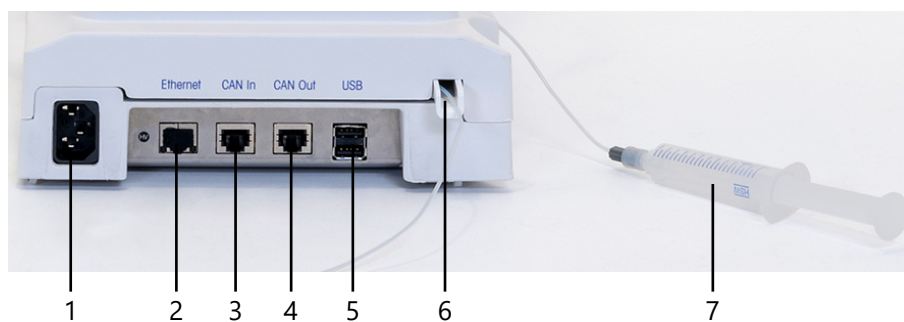

|   |                         |   |                    |
|---|-------------------------|---|--------------------|
| 1 | Socket for power supply | 4 | CAN Out connection |
| 2 | Ethernet connection     | 5 | USB ports (1-2)    |
| 3 | CAN In connection       | 6 | Drip pan outlet    |

## 4 Installation

### 4.1 Installation requirements

#### Site requirements

The instrument has been developed for indoor operation in a well-ventilated area. Avoid the following environmental influences:

- Conditions outside of the ambient conditions specified in the technical data
- Powerful vibrations
- Direct sunlight
- Corrosive gas atmosphere
- Explosive atmosphere of gases, steam, fog, dust and flammable dust
- Powerful electric or magnetic fields

### 4.2 Transport the device

To transport the device from one laboratory workplace to another, please proceed as follows:

- 1 If EasySampler 1210 has been in use before, run a **Clean** process.
- 2 Carry EasySampler 1210 only with two hands gripping the front and back handles.



### 4.3 Install the vial rack

- 1 Assemble the vials by mounting the caps.
- 2 Insert the vials into the rack. Ensure they are properly inserted.



- 3 Align the blue arrow on the rack with the blue arrow on EasySampler 1210.

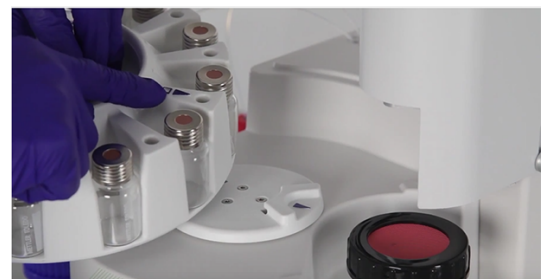

- 4 Rotate the rack lever clockwise to lock it in place.



#### 4.4 Connect the sampling probe

- 1 Place the sampling probe into its holder and ensure it is securely positioned. For probes 450 and 330 use the vial adapter for fixation.



- 2 Secure the conduit to the conduit holder.



- 3 Connect the sampling probe lines (grey line to the grey port and black line to the black port; to avoid leaks, screw the fitting nuts in until you hear a "click" ).
- 4 Connect the probe power cable to the socket.



#### 4.5 Install the needle

- 1 Carefully insert the needle into its holder.



- 2 Fix the needle in place with the knurled screw.



- 3 Connect the fitting nut to the needle and screw the fitting nut in until you hear a "click".



- 4 Mount the needle protection shield, taking care not to pinch the tubing.



## 4.6 Connect power to device



### **WARNING**

#### **Risk of electric shock**

- 1 Make sure to plug the power cable supplied into a power supply outlet that is grounded. A technical fault could otherwise result in serious injury or death.
- 2 Only use the METTLER TOLEDO power supply cable and AC power adapter designed for your instrument.

- 1 Connect the power cable on the rear of the device (100 – 240 V, 50/60 Hz).
- 2 Insert the plug of the power cable into a grounded power outlet that is easily accessible.



## 4.7 Turn on device

- Press the power button on the front of the device.
- ➔ EasySampler 1210 requires a **Clean** process.



## 5 Operation

### 5.1 Rinse the pump

To ensure good operation of the pump a manual rinsing before and after each experiment is recommended. Use the EasySampler Pump Rinsing Set (30466882) for the manual rinsing of the pump. Once installed the rinsing set can remain connected during normal operation.

For more instructions on rinsing the pump go to [mt.com\EasySampler](http://mt.com\EasySampler). Select the Support tab and watch the video: How to install and use the EasySampler Pump Rinsing Set.

- The pump rinsing set is installed.
  - 1 Place the long waste tubing into a waste receptacle.
  - 2 Choose a solvent capable of dissolving any potential solids.
  - 3 Fill the syringe with the solvent.



- 4 Re-connect the syringe to the luer locker adapter.
- 5 Start a **Clean** process from the touchscreen.
- 6 While **Clean** process is running, push the solvent (30 mL) in the syringe through the upper rinse port.



- 7 If needed repeat the procedure with another solvent.
- 8 Execute a final rinsing with isopropanol while **Clean** is still running.



### 5.2 Clean

**Note** The sampling probe is not yet inserted in the reactor.

Perform a pump rinsing during a **Clean** process to avoid blockages of the EasySampler.

- 1 Select **Clean**.

2 Follow the instructions on the touchscreen and press **OK**.

➔ EasySampler 1210 starts the **Clean** process.

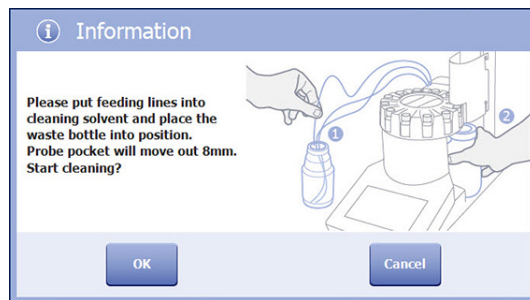



➔ Once the **Clean** process is finished, the **Prepare** button becomes active.

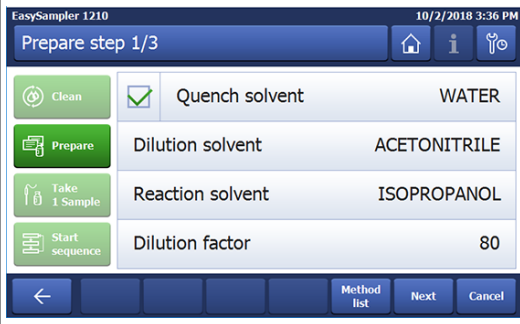
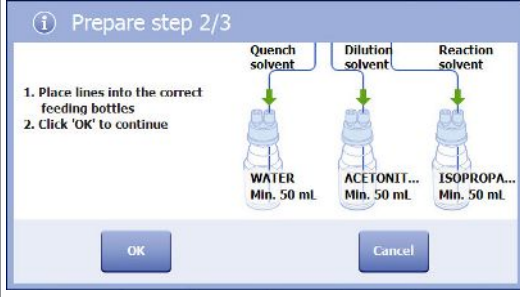
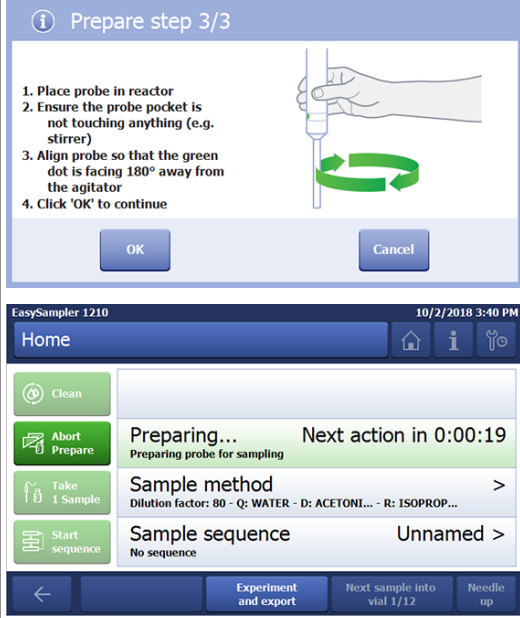

## 5.3 Prepare

**Note** The sampling probe is not yet inserted in the reactor.

|  |  |
|--|--|
| <ol style="list-style-type: none"> <li>1 Select <b>Prepare</b>.</li> <li>2 Enter the <b>Quench solvent</b> (if no <b>Quench solvent</b> is selected, <b>Dilution solvent</b> is used instead).</li> <li>3 Enter the <b>Dilution solvent</b>.</li> <li>4 Enter the <b>Reaction solvent</b>.</li> <li>5 Enter a <b>Dilution Factor</b> between 80 and 450.</li> <li>6 Select <b>Next</b>.</li> </ol>   |    |
| <ol style="list-style-type: none"> <li>7 Follow the instructions on the touchscreen.</li> <li>8 Select <b>OK</b>. <ul style="list-style-type: none"> <li>➔ EasySampler 1210 starts a <b>Prepare</b> process to fill all feeding lines with the relevant solvents.</li> <li>➔ The touchscreen indicates the time to place the sampling probe into the reactor and the pocket will move out (8 mm).</li> </ul> </li> </ol>   |    |
| <ol style="list-style-type: none"> <li>9 Loosen the collar (with the green dot) on the probe headpiece and align the green dot with the pocket.</li> <li>10 Tighten the collar.</li> <li>11 Fit an appropriate adapter onto the sampling probe.</li> <li>12 Carefully insert the sampling probe into the EMPTY reactor.</li> <li>13 Adjust the height of the sampling probe in the reactor so that the probe tip remains clear of any other inserts, stirrer and reactor wall.</li> <li>14 Tighten the adapter onto the sampling probe so that the height of the probe in the reactor is fixed.</li> <li>15 Remove the sampling probe from the reactor.</li> <li>16 Select <b>OK</b>. <ul style="list-style-type: none"> <li>➔ EasySampler 1210 fills the lines and sample pocket with <b>Reaction solvent</b>.</li> </ul> </li> </ol> |   |
| <ol style="list-style-type: none"> <li>17 Prepare the reactor for the reaction by adding the necessary solvents, starting materials and reagents.</li> <li>18 Place the sampling probe into an appropriate port of the reactor lid and turn the sampling probe so that the sample pocket (indicated by the green dot) faces 180° away from the stirrer. <ul style="list-style-type: none"> <li>➔ The position of the pocket will ensure accurate and reproducible sampling of heterogeneous reactions.</li> </ul> </li> <li>19 Ensure the probe tip is immersed in the reaction mixture. <ul style="list-style-type: none"> <li>➔ EasySampler 1210 is now ready to take samples.</li> </ul> </li> </ol>  |  |



## 5.4 Take 1 Sample

- 1 Select **Take 1 Sample**.
  - 2 Confirm the sample method with **OK** or change by pressing **Cancel**.
- ➔ EasySampler 1210 starts sampling and the touch-screen displays the remaining time and the activity of the device.

EasySampler 1210 is ready to take further samples as soon as the sampling process is finished.

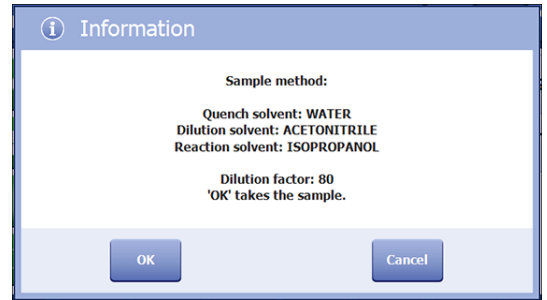

## 6 Maintenance

This section describes simple routine checks and maintenance procedures that are easily performed by the user to ensure optimal system performance. Regular checks and maintenance ensure the proper function of EasySampler 1210.

Maintenance tasks have to be performed in accordance with the instructions given in this chapter. After performing any maintenance tasks, it should be ensured that the device still meets all safety requirements.

Ask your local support team for the service contract option to ensure continuous running and reliable performance of the device.

### 6.1 Pause during the Operation of EasySampler 1210

If EasySampler 1210 has been switched off for 24 hours, a **Clean** process is recommended before starting a sampling process. This will ensure no bubbles are present in the solvent lines. A **Prepare** process is then required.

### 6.2 Checking for Leaks

Check that all fluid line connectors are tight and in good condition. "Click and fit" connectors are used on all EasySampler 1210 fittings. To ensure a seal is achieved, the fitting must be tightened until an audible click is heard.

### 6.3 Cleaning the EasySampler 1210



#### NOTICE

##### **Damage to the device due to incompatible cleaning agents**

Inappropriate cleaning agents could damage the housing of the device.

- 1 Use the described cleaning agent.
- 2 Should you use other cleaning agents, ensure that they are compatible with the housing material.

The housing of the instrument is not watertight (i.e. splash proof). We therefore recommend that you clean the housing with a cloth soaked in a mild solvent such as isopropanol or ethanol.



If you have questions about the compatibility of cleaning agents, contact your authorized METTLER TOLEDO dealer or service representative.

## 6.4 Touchscreen Firmware Update

An empty USB stick is required to perform the firmware update.

Download the current version of the touchscreen firmware from <https://community.autochem.mt.com>. Login and navigate to products -> Software -> Other Software and Firmware.

You can find a how to video on [mt.com\EasySampler](https://community.autochem.mt.com/EasySampler) under the Support tab: Update EasySampler Firmware.

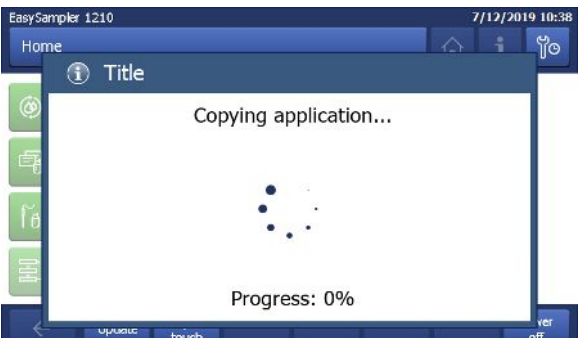
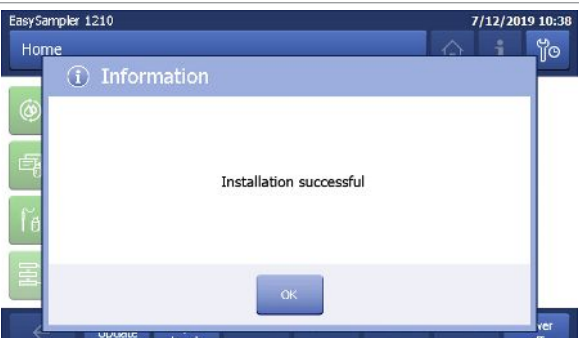
| Description  | Sequence   |
|--|--|
| <p>1 Download the .zip archive containing the software and extract the folder to an empty USB stick.</p>   |    |
| <p>2 Switch off EasySampler 1210.<br/>3 Remove the dongle before the firmware update.<br/>4 Insert the USB stick into any USB port of EasySampler 1210.<br/>5 Switch on EasySampler 1210.<br/>6 Select <b>Update</b>.<br/>7 Tap <b>OK</b> to accept the EULA (end user license agreement).</p> |    |
| <p>8 Wait until the installation is completed, this will take several minutes.<br/><b>Note</b> Do not remove the USB stick until the firmware update is completed.</p>   |   |
| <p>9 The firmware update has been installed successfully.<br/>10 Select <b>OK</b>.<br/>11 Press <b>Power off</b>.<br/>12 Remove the USB stick.<br/>13 Switch on EasySampler 1210.<br/>14 Insert the dongle again in a USB port of the EasySampler 1210.</p>                                    |  |

## 6.5 Disposal

In conformance with the European Directive 2012/19/EU on Waste Electrical and Electronic Equipment (WEEE) this device may not be disposed of in domestic waste. This also applies to countries outside the EU, per their specific requirements.

Please dispose of this product in accordance with local regulations at the collecting point specified for electrical and electronic equipment. If you have any questions, please contact the responsible authority or the distributor from which you purchased this device. Should this device be passed on to other parties, the content of this regulation must also be related.



## 7 Technical Data

Certifications regarding this product can be found at <https://www.mt.com/us/en/home/search/compliance.html/>  
The product name of your device is the model number.

### EasySampler 1210 System

|                  |   |
|------------------|---|
| Materials        | Housing: Polypropylene PP 30% Talcum<br>Tubing: PTFE<br>Needle: Stainless steel<br>Valve: Ceramic<br>Pump: Ceramic, PTFE<br>Protective foil touchscreen: polyester film |
| Power Connection | 100...240 V; 50/60 Hz   |
| User Interface   | METTLER TOLEDO Touchscreen  |
| Weight           | 9 kg, 20 lbs  |
| Vials            | 10 mL, borosilicate glass   |
| Rack             | 12 x 10 mL vials  |

### Ambient conditions

|                             |   |
|-----------------------------|---|
| <b>Humidity</b>             | Max. relative humidity 80 % for temperatures up to 31 °C decreasing linearly to 50 % relative humidity at 40 °C |
| <b>Altitude</b>             | Up to 2000 m  |
| <b>Overvoltage category</b> | II  |
| <b>Pollution degree</b>     | 2   |
| <b>Ambient temperature</b>  | 5 °C...40 °C  |
| <b>Usage</b>                | For indoor use only   |

### EasySampler Probe

|                           | <b>210</b>  | <b>330</b>        | <b>450</b>        |
|---------------------------|---|-------------------|-------------------|
| Weight                    | 0.8 kg, 1.76 lbs  | 0.84 kg, 1.85 lbs | 0.88 kg, 1.94 lbs |
| Length                    | 213 mm / 8.38"  | 333 mm / 13.11"   | 453 mm / 17.83"   |
| Materials                 | Wetted parts: Alloy C-22, PTFE<br>Non-wetted parts: Anodized aluminum, stainless steel  |                   |                   |
| Pocket Size               | 20 µL ±10%  |                   |                   |
| Temperature Range         | -20 °C to 140 °C (for reactions at atmospheric pressure)  |                   |                   |
| Pressure                  | 1.013 bar to 10 bar, 14.7 psi to 145 psi with the following conditions: <ul style="list-style-type: none"> <li>• Temperature range: 20 °C to 100 °C</li> <li>• Maximum reactor volume: 2500 mL</li> </ul> |                   |                   |
| Recommended sleeve change | <ul style="list-style-type: none"> <li>• At ambient pressure: every 100 samples</li> <li>• At elevated pressure: after each experiment or 24 samples (maximum 24 samples per reaction)</li> </ul>         |                   |                   |
| Minimum Sampling Interval | 2 min 52 sec  |                   |                   |
| pH                        | 1 to 14   |                   |                   |

|  |   |
|--|---|
| <p><b>Supported Firmware and Software for Connectivity kit</b></p> | <p><b>Touchscreen to Touchscreen Control:</b><br/> EasySampler: Firmware Version 1.1.0.0 or higher<br/> EasyMax, OptiMax and RX-10: Firmware Version 5.4.0.0 or higher</p> <p><b>Compatibility with iControl Software:</b><br/> EasySampler: Firmware Version 5.5.0.0 or higher<br/> EasyMax, OptiMax and RX-10: Firmware Version 5.5.0.0 or higher<br/> iControl: Software Version 5.5 or higher</p> |
|--|---|

## 7.1 Solvent compatibility

The materials of construction are listed in the technical data (above). When selecting solvents, ensure they are compatible with all the wetted parts of EasySampler 1210 and also the sampling probe.

## 7.2 Dimensions

### 7.2.1 Device Dimensions

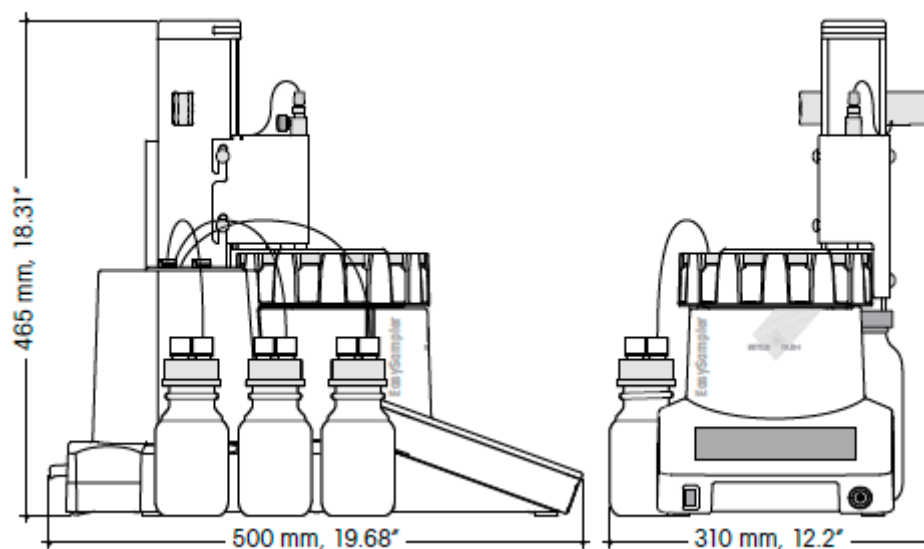

### 7.2.2 Probe Dimensions

#### Probe 210

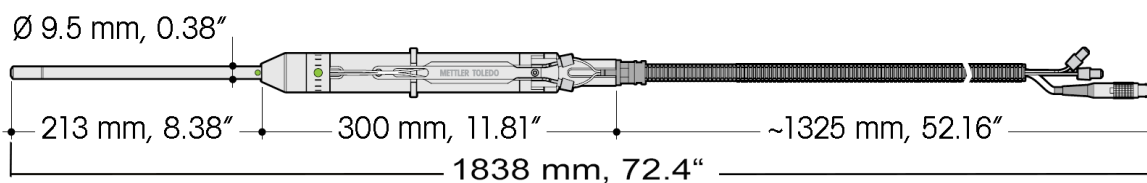

#### Probe 330

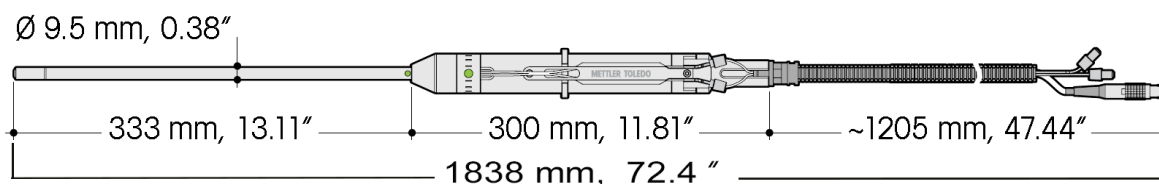

**Probe 450**

Ø 9.5 mm, 0.38"

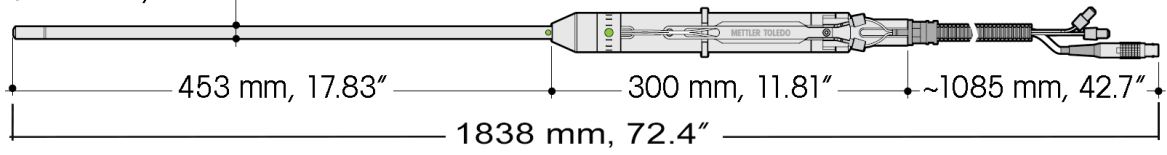

## 8 Certifications

### 8.1 Information\_Notice\_EasySampler\_Pressure Directive\_2014\_68\_EU.pdf

## Manufacturing of Pressure Assemblies

In reference to 2014/68/EU

**Pressure Assemblies:** EasySampler Probe 450 (part number: 30279540)  
EasySampler Probe 330 (part number: 30306934)  
EasySampler Probe 210 (part number: 30043400)

**Manufacturer:** Mettler Toledo GmbH, Im Langacher, Greifensee (CH)

#### Product Specifications at elevated pressure

|  |                    |
|--|--------------------|
| Maximum / Minimum specified Pressure (PS)    | 10 bar / 1.013 bar |
| Maximum / Minimum specified Temperature (TS) | 100 °C / 20 °C     |
| Maximum Reactor Volume applied:              | 2500 mL            |
| Nominal Size of EasySampler Probe (DN)       | < 6                |

**Safety Equipment:** None

**Classification according directive 2014/68/EU** Annex II/Chapter 4 Paragraph 3

#### Conformity Assessment Procedure

The listed pressure assemblies are outside the scope of directive 2014/68/EU, Chapter 1, Article 1, 2(f) with reference to Article 13 and in accordance with Annex II of this directive. Design specification, manufacturing and testing has been conducted in accordance with the sound engineering practice in order to ensure safe use. Applied parameters in product testing: 20 to 110 °C temperature range, 17.5 bar pressure, reactor volume of 100 mL.

#### CE Labeling

According to chapter 4 (3) of the directive 2014/68/EU the listed pressure assemblies shall not bear the CE marking referred to in the directive 2014/68/EU.

Instructions for safe use are included in the EasySampler operating instructions.

Date and Location

Manufacturer

Signature

May, 17 2016 Schwerzenbach

METTLER TOLEDO



Head Strategic Product Group CSS

METTLER TOLEDO







**To protect your product's future:**  
METTLER TOLEDO Service assures  
the quality, measuring accuracy and  
preservation of value of this product  
for years to come.

Please request full details about our  
attractive terms of service.

**www.mt.com**

For more information

**Mettler-Toledo GmbH**

Im Langacher 44  
8606 Greifensee, Switzerland  
[www.mt.com/contact](http://www.mt.com/contact)

Subject to technical changes.  
© Mettler-Toledo GmbH 01/2021  
30091776C



30091776